



Technical Data

LAVATORY-MOUNTED SOAP DISPENSER FOR SOAPS, LOTIONS, AND DETERGENTS

B-8221



Patented

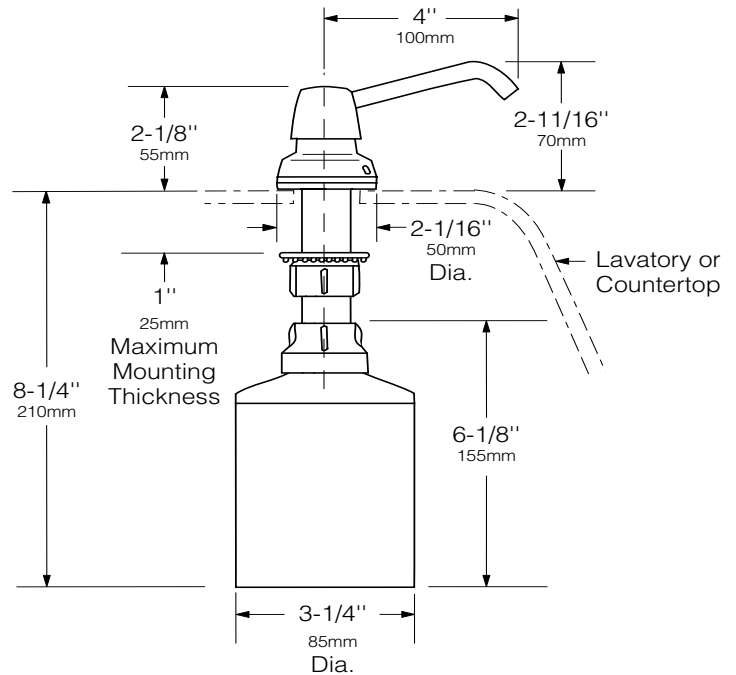

MATERIALS:

Piston, Spout, and Top Cover — Type-304 stainless steel with bright polished finish.

Cover Spacer — Rigid, impact-resistant polyester.

Escutcheon — Chrome-plated, high-impact-resistant ABS with bright polished finish. Concealed locking mechanism.

Body and Shank — High-impact-resistant ABS.

Valve — ABS cylinder. Stainless steel spring. U-packing seal and duckbills. Corrosion-resistant to most soaps and detergents.

Container — Translucent, shatter-resistant polyethylene. Capacity: 20 fl oz (0.59 L).

OPERATION:

Press piston down to dispense liquid and lotion soaps, and synthetic detergents. Valve operates with one hand, without tight grasping, pinching, or twisting of the wrist, and with less than 5 pounds of force (22.2 N) to comply with barrier-free accessibility guidelines (including ADAAG in U.S.A.). Vandal-resistant spout can rotate 360° without damage to unit. Escutcheon locks to body with concealed locking mechanism that is opened only with special key provided. To fill from top, unlock cover and remove piston, spout, and supply-tube assembly. Unit may also be filled by removing container from below lavatory.

Designer's Note: Do not use E4-rated antibacterial soaps (active ingredient PCMX or Triclosan), iodine-based surgical soaps, or alcohol-based antiseptic solutions in this unit. Soap valve is not designed to dispense these types of corrosive soaps.

INSTALLATION:

Unit is designed for installation in 1±1/16" (25±1.6mm) diameter hole in porcelain-enameled steel, cast-iron or vitreous-china lavatories, as well as in countertops adjacent to lavatories. Unit may be mounted in unused faucet hole or through special hole requisitioned when lavatory is ordered from manufacturer (specify punching location). Shank accommodates maximum 1" (25mm) mounting thickness and can be cut in the field. Clearance required for container diameter is 3-1/4" (85mm).

SPECIFICATION:

Lavatory-mounted soap dispenser shall dispense liquid and lotion soaps, and synthetic detergents. Valve shall be operable with one hand and with less than 5 pounds of force (22.2 N) to comply with barrier-free accessibility guidelines (including ADAAG in U.S.A.). Piston and spout assembly shall be type-304 stainless steel with bright polished finish. Escutcheon shall lock to body with concealed locking mechanism that is opened only with special key provided. Spout shall rotate 360° without damage to valve mechanism. Piston, spout, and supply-tube assembly shall be removable from top for filling and maintenance. Valve shall have ABS cylinder, stainless steel spring, U-packing seal, and duckbills. Shank shall accommodate mounting thicknesses up to 1" (25mm). Translucent, shatter-resistant polyethylene container shall have a capacity of 20 fl oz (0.59 L). Manufacturer's service and parts manual shall be provided to the building owner/manager upon completion of project.

Lavatory-Mounted Soap Dispenser shall be Model B-8221 of Bobrick Washroom Equipment, Inc., Clifton Park, New York; Jackson, Tennessee; Los Angeles, California; Bobrick Washroom Equipment of Canada Ltd., Scarborough, Ontario; Bobrick Washroom Equipment Pty. Ltd., Australia; and Bobrick Washroom Equipment Limited, United Kingdom.